

WIT2411

2.4GHz Spread Spectrum Wireless Industrial Transceiver

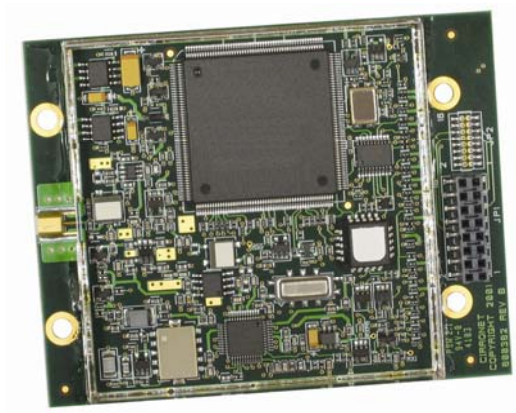

Integration Guide



Important Regulatory Information

**Cirronet Product FCC ID: HSW-2411
IC 4492A-2411**

Note: This unit has been tested and found to comply with the limits for a Class A digital device, pursuant to part 15 of the FCC Rules. These limits are designed to provide reasonable protection against harmful interference when the equipment is operated in a commercial environment. This equipment generates, uses, and can radiate radio frequency energy and, if not installed and used in accordance with the instruction manual, may cause harmful interference to radio communications. Operation of this equipment in a residential area is likely to cause harmful interference in which case the user will be required to correct the interference at their expense.

FCC s MPE Requirements

Information to user/installer regarding FCC s Maximum Permissible Exposure (MPE) limits.

Notice to users/installers using the 24 dBi parabolic dish antenna in conjunction with all Cirronet RF products.

FCC rules limit the use of this antenna, when connected to Cirronet RF products for **point-to-point applications only**. It is the responsibility of the installer to ensure that the system is prohibited from being used in point-to-multipoint applications, omni-directional applications, and applications where there are multiple co-located intentional radiators transmitting the same information. Any other mode of operation using this antenna is forbidden.

Notice to users/installers using the following fixed antennas, with Cirronet RF products:

<p>Andrews 24dBi parabolic dish Andrews 18dBi parabolic dish Cushcraft 15dBi Yagi, Mobile Mark 14dBi Corner Reflector, Mobile Mark 9dBi Corner Reflector</p>	<p>The field strength radiated by any one of these antennas, when connected to Cirronet RF products, may exceed FCC mandated RF exposure limits. FCC rules require professional installation of these antennas in such a way that the general public will not be closer than 2 m from the radiating aperture of any of these antennas. End users of these systems must also be informed that RF exposure limits may be exceeded if personnel come closer than 2 m to the apertures of any of these antennas.</p>
--	--

Notice to users/installers using the following mobile antennas, with Cirronet RF products:

<p>Mobile Mark 12dBi omni-directional, Mobile Mark 9dBi omni-directional, MaxRad 5dBi whip, Cirronet Patch antenna, Ace 2dBi dipole, Mobile Mark 2dBi Stub</p>	<p>The field strength radiated by any one of these antennas, when connected to Cirronet RF products, may exceed FCC mandated RF exposure limits. FCC rules require professional installation of these antennas in such a way that the general public will not be closer than 20 cm from the radiating aperture of any of these antennas. End users of these systems must also be informed that RF exposure limits may be exceeded if personnel come closer than 20 cm to the apertures of any of these antennas.</p>
--	--

Declaration of Conformity



Warning! The RLAN transceiver within this device uses a band of frequencies that are not completely harmonized within the European Community. Before using, please read the European Operation Section of the Products User's Guide for limitations.

0889 is the identification number of RADIO FREQUENCY INVESTIGATION LTD - Ewhurst Park, Ramsdell RG26 5RQ Basingstoke, United Kingdom – the Notified Body having performed part or all of the conformity assessment on the product.

The WIT2411 to which this declaration relates is in conformity with the essential requirements of the R&TTE directive 1999/5/EC and complies with the following standards and/or other normative documents:

For Interfaces

EN 55022

EN 55024

For RLAN Transceiver

EN 300 328

EN 301 489 -1, -17

EN 60950

Canadian Department of Communications Industry Canada (IC) Notice

Canadian Department of Communications Industry Canada (IC) Notice

This apparatus complies with Health Canada's Safety Code 6 / IC RSS 102.

"To prevent radio interference to the licensed service, this device is intended to be operated indoors and away from windows to provide maximum shielding. Equipment (or its transmit antenna) that is installed outdoors may be subject to licensing."

ICES-003

This digital apparatus does not exceed the Class B limits for radio noise emissions from digital apparatus as set out in the radio interference regulations of Industry Canada.

Le présent appareil numérique n'émet pas de bruits radioélectriques dépassant les limites applicables aux appareils numériques de Classe B prescrites dans le règlement sur le brouillage radioélectrique édicté par Industrie Canada.

TABLE OF CONTENTS

1. INTRODUCTION	1
1.1. Why Spread Spectrum?	1
1.2. Frequency Hopping vs. Direct Sequence.....	2
2. RADIO OPERATION	5
2.1. Synchronization and Registration.....	5
2.2. Data Transmission	6
2.2.1. Point-to-Point	6
2.2.2. Point-to-Multipoint	7
2.2.3. Handle Assignment.....	7
2.2.4. TDMA Operation.....	8
2.2.5. Full Duplex Communication.....	10
2.2.6. Error-free Packet Transmission Using ARQ.....	10
2.3. Modes of Operation	12
2.3.1. Control and Data Modes	12
2.3.2. Sleep Mode	12
2.3.4. RF Flow Control Mode.....	13
3. PROTOCOL MODES	14
3.1.3. Connect Packet.....	16
3.1.4. Disconnect Packet (base only, receive only)	16
4. MODEM INTERFACE	17
4.1. Interfacing to 5 Volt Systems	18
4.2. Evaluation Unit and Module Differences	18
4.3. Three-Wire Operation.....	18
5. MODEM COMMANDS.....	19
5.1. Serial Commands.....	19
5.2. Network Commands	20
5.3. Protocol Commands.....	21
5.4. Status Commands	23
5.5. Memory Commands	24
5.6. Modem Command Summary.....	25
6. WIT2411 DEVELOPER'S KIT	26
7. WinCOM.....	28
7.1. Starting the program	30
7.2. Function Keys.....	33
7.3. WinCom Tools.....	34
7.4. Script Commands.....	36
7.5. Demonstration Procedure	38
8. Troubleshooting.....	39

9. APPENDICES	41
9.1. Technical Specifications	41
9.1.1. Ordering Information	41
9.1.2. Power Specifications	41
9.1.3. RF Specifications	41
9.1.4. Mechanical Specifications	41
9.2. Serial Connector Pinout	42
9.3. Approved Antennas	42
9.4. Technical Support	43
9.5. Reference Design	44
9.6. Mechanical Drawing – WIT2411D	45
10. Warranty	46

1. INTRODUCTION

The WIT2411 radio transceiver provides reliable wireless connectivity for either point-to-point or multipoint applications. Frequency hopping spread spectrum technology ensures maximum resistance to noise and multipath fading and robustness in the presence of interfering signals, while operation in the 2.4GHz ISM band allows license-free use and worldwide compliance. A simple serial interface supports asynchronous data up to 921600 bps. An on-board 12 KB buffer and an error-correcting over-the-air protocol provide smooth data flow and simplify the task of integration with existing applications.

- Multipath fading impervious frequency hopping technology with 43 frequency channels (2401-2475 MHz).
 - Supports point-to-point or multipoint applications.
 - Meets FCC rules 15.247 and ETS 300.328 for worldwide license-free operation.
 - Superior range to 802.11 wireless LAN devices.
 - Transparent ARQ protocol w/12KB buffer ensures data integrity.
 - Digital addressing supports up to 64 networks, with 62 remotes per network.
 - Low power 3.3v CMOS signals
 - Fast acquisition typically locks to hopping pattern in 2 seconds or less.
 - Selectable 8 mW or 18 mW transmit power.
 - Built-in data scrambling reduces possibility of eavesdropping.
 - Nonvolatile memory stores configuration when powered off.
 - Smart power management features for low current consumption.
 - Dynamic TDMA slot assignment that maximizes throughput.
- Simple serial interface handles both data and control at 115,200 or 921600 bps.

1.1. Why Spread Spectrum?

The radio transmission channel is very hostile, corrupted by noise, path loss and interfering transmissions from other radios. Even in a pure interference-free environment, radio performance faces serious degradation through a phenomenon known as multipath fading. Multipath fading results when two or more reflected rays of the transmitted signal arrive at the receiving antenna with opposing phase, thereby partially or completely canceling the desired signal. This is a problem particularly prevalent in indoor installations. In the frequency domain, a multipath fade can be described as a frequency-selective notch that shifts in location and intensity over time as reflections change due to motion of the radio or objects within

its range. At any given time, multipath fades will typically occupy 1% - 2% of the 2.4 GHz band. This means that from a probabilistic viewpoint, a conventional radio system faces a 1% - 2% chance of signal impairment at any given time due to multipath.

Spread spectrum reduces the vulnerability of a radio system to interference from both jammers and multipath fading by distributing the transmitted signal over a larger region of the frequency band than would otherwise be necessary to send the information. This allows the signal to be reconstructed even though part of it may be lost or corrupted in transit.

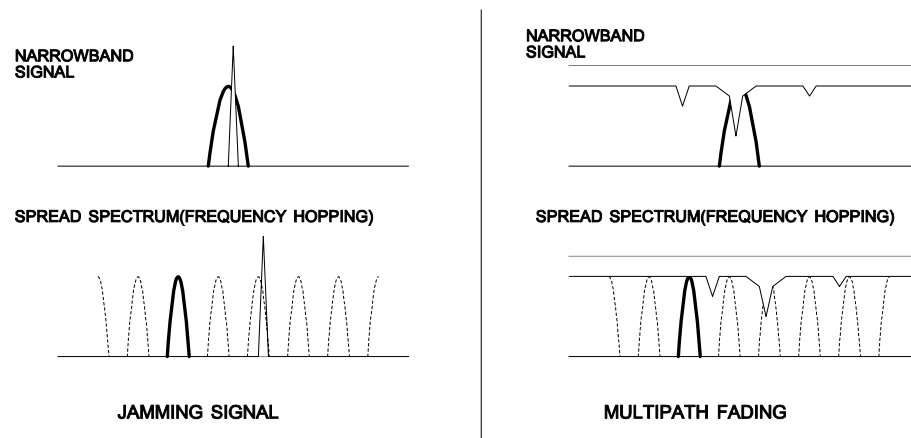

Figure 1

Narrowband vs. spread spectrum in the presence of interference

1.2. Frequency Hopping vs. Direct Sequence

The two primary approaches to spread spectrum are direct sequence (DS) and frequency hopping (FH), either of which can generally be adapted to a given application. Direct sequence spread spectrum is produced by multiplying the transmitted data stream by a much faster, noise-like repeating pattern. The ratio by which this modulating pattern exceeds the bit rate of the baseband data is called the processing gain, and is equal to the amount of rejection the system affords against narrowband interference from multipath and jammers. Transmitting the data signal as usual, but varying the carrier frequency rapidly according to a pseudo-random pattern over a broad range of channels produces a frequency hopping spectrum system.

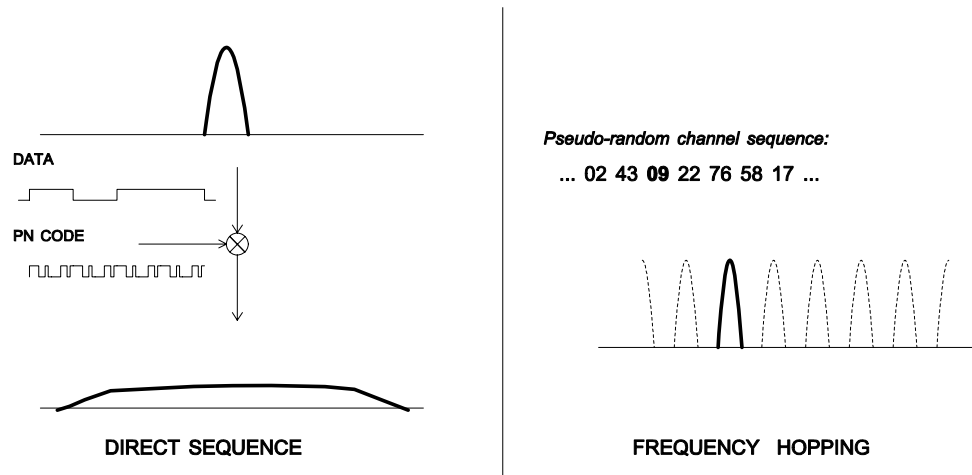

Figure 2
Forms of spread spectrum

One disadvantage of direct sequence systems is that due to spectrum constraints and the design difficulties of broadband receivers, they generally employ only a minimal amount of spreading (typically no more than the minimum required by the regulating agencies). For this reason, the ability of DS systems to overcome fading and in-band jammers is relatively weak. By contrast, FH systems are capable of probing the entire band if necessary to find a channel free of interference. Essentially, this means that a FH system will degrade gracefully as the channel gets noisier while a DS system may exhibit uneven coverage or work well until a certain point and then give out completely.

Because it offers greater immunity to interfering signals, FH is often the preferred choice for co-located systems. Since direct sequence signals are very wide, they tend to offer few non-overlapping channels, whereas multiple hoppers may interleave with less interference. Frequency hopping does carry some disadvantage in that as the transmitter cycles through the hopping pattern it is nearly certain to visit a few blocked channels where no data can be sent. If these channels are the same from trip to trip, they can be memorized and avoided; unfortunately, this is generally not the case, as it may take several seconds to completely cover the hop sequence during which time the multipath delay profile may have changed substantially. To ensure seamless operation throughout these outages, a hopping radio must be capable of buffering its data until a clear channel can be found. A second consideration of frequency hopping systems is that they require an initial acquisition period during which the receiver must lock on to the moving carrier of the transmitter before any data can be sent, which typically takes several seconds. In summary, frequency hopping systems generally feature greater coverage and channel utilization than comparable direct sequence systems. Of course, other implementation factors such as size, cost, power consumption and ease of implementation must also be considered before a final radio design choice can be made.

As an additional benefit, RF spectrum has been set aside at 2.4 GHz in most countries (including the U.S.) for the purpose of allowing compliant spread spectrum systems to operate freely without the requirement of a site license. This regulatory convenience alone has been a large motivation for the industry-wide move toward spread spectrum.

2. RADIO OPERATION

2.1. Synchronization and Registration

As discussed above, frequency hopping radios periodically change the frequency at which they transmit. In order for the other radios in the network to receive the transmission, they must be listening to the frequency over which the current transmission is being sent. To do this, all the radios in the net must be synchronized and must be set to the same hopping pattern.

In point-to-point or point-to-multipoint arrangements, one radio module is designated as the base station. All other radios are designated remotes. One of the responsibilities of the base station is to transmit a synchronization signal to the remotes to allow them to synchronize with the base station. Since the remotes know the hopping pattern, once they are synchronized with the base station, they know which frequency to hop to and when. Every time the base station hops to a different frequency, it immediately transmits a synchronizing signal.

When a remote is powered on, it rapidly scans the frequency band for the synchronizing signal. Since the base station is transmitting over up to 43 frequencies and the remote is scanning up to 43 frequencies, it can take several seconds for a remote to synch up with the base station.

Once a remote has synchronized with the base station, it must request registration from the base station. The registration process identifies to the base station the remotes from which transmissions will be received and not discarded. Registration also allows tracking of remotes entering and leaving the network. The base station builds a table of serial numbers of registered remotes. To improve efficiency, the 24-bit remote serial number is assigned a 6-bit “handle” number. Two of these are reserved for system use, thus each base station can register 62 separate remotes. This handle is how user applications will know the remotes. Note that if a remote leaves the coverage area and then re-enters, it may be assigned a different handle.

To detect if a remote has gone offline or out of range, the registration must be “renewed” once every 256 hops. Registration is completely automatic and requires no user application intervention. When the remote is registered, it will receive several network parameters from the base. This allows the base to automatically update these network parameters in the remotes over the air. Once a parameter has been changed in the base, it is automatically changed in the remotes. The parameters automatically changed are *hop duration* and *hop set*.

At the beginning of each hop, the base station transmits a synchronizing signal. After the synchronizing signal has been sent, the base will transmit any data in its buffer. The amount of data that the base station can transmit per hop is determined by the *base slot size* parameter. If there is no data to be sent, the base station will not transmit data until the next frequency.

The operation for remotes is similar to the base station without the synchronizing signal. The amount of data a remote can send on one hop is dependent upon the *hop duration*, the *base slot size* and the number of remotes currently transmitting data. A detailed explanation of this relationship is provided in Section 2.2.3.

Except for the registration process that occurs only when a remote logs onto the network, the whole procedure is repeated on every frequency hop. Refer to the section on *Modem Commands* for complete details on parameters affecting the transmission of data.

2.2. Data Transmission

The WIT2411 supports two network configurations: point-to-point and point-to-multipoint. In a point-to-point network, one radio is set up as the base station and the other radio is set up as a remote. In a point-to-multipoint network, a star topology is used with the radio set up as a base station acting as the central communications point and all other radios in the network set up as remotes. In this configuration, all communications take place between the base station and any one of the remotes. Remotes cannot communicate directly with each other.

2.2.1. Point-to-Point

In point-to-point mode, the base station will transmit whatever data is in its buffer limited to 65,536 bytes or as limited by the *base slot size*. If the base station has more data than can be sent on one hop, the remaining data will be sent on subsequent hops. In addition to the data, the base station adds some information to the transmission over the RF link. It adds the address of the remote to which it is transmitting, even though in a point-to-point mode there is only one remote. It also adds a sequence number to identify the transmission to the remote. This is needed in the case of acknowledging successful transmissions and retransmitting unsuccessful transmissions. Also added is a 24-bit CRC to allow the base to check the received transmission for errors. When the remote receives the transmission, it will acknowledge the transmission if it was received without errors. If no acknowledgment is received, the base station will retransmit the same data on the next frequency hop.

In point-to-point mode, a remote will transmit whatever data is in its buffer up to the limit of its transmit slot or slots. If the remote has more data than can be sent on one hop, it will send as much data as possible as a packet, adding its own address, a packet sequence number and 24-bit CRC. These additional bytes are transparent to the user application if the protocol mode is 00 (which is the default). In the event a remote has more data to send, the data will be sent on subsequent hops. If the transmission is received by the base station without errors, the base station will acknowledge the transmission. If the remote does not receive an acknowledgment, it will retransmit the data on the next frequency hop. To the user application, acknowledgments and retransmissions all take place behind the scenes without the need for user intervention.

The WIT2411 has a point-to-point direct mode which fixes the remote radio's handle at 30H. This mode is recommended for point-to-point applications, especially if the remote is likely to periodically leave and re-enter the coverage area of the base. See the section on *Network Commands* for details of this mode.

2.2.2. Point-to-Multipoint

In point-to-multipoint mode, data sent from the user application to the base station must be packetized by the user application unless the remote device can distinguish between transmissions intended for it and transmissions intended for other remote devices. This is necessary to identify the remote to which the base station should send data. When the user packet is received by the remote, if the remote is in transparent mode (protocol mode 0), the packetization bytes are stripped by the remote. In this instance the remote host receives just data. If the remote is not in transparent mode, the remote host will receive the appropriate packet header as specified by the remote's protocol mode. Refer to the section *Protocol Modes* for details on the various packet formats.

When a remote sends data to a base station in point-to-multipoint mode, the remote host does not need to perform any packetization of the data. Remotes can operate in transparent mode even though the base is operating in a packet mode. The remote will add address, sequence and CRC bytes as in the point-to-point mode. When the base station receives the data, the base station will add packetization header bytes according to its *protocol mode* setting.

If the remote device can determine if a particular transmission is intended for it (e.g. there is addressing information contained in the data payload), broadcast mode can be used. In this mode, the *default handle* is set to a value of 63 (3FH). In broadcast mode, all remotes will receive all transmissions and thus it is up to the remote device to determine for which device a particular transmission is intended. In this mode, *ARQ retries* becomes a redundant transmit count, that is, the number of times the base radio will broadcast each transmission. This is provided since the ARQ mechanism must be disabled in broadcast mode. Once a remote radio has successfully received a transmission from the base, any subsequent transmissions of the same data is discarded by the remote radio. So just one copy of each transmission will be transmitted to the remote device by the remote radio.

2.2.3. Handle Assignment

Handles are used to reduce overhead by not sending the unique 24-bit serial number ID of a remote when sending or receiving data. The use of the various protocol modes causes the base radio to issue CONNECT packets when a new remote registers with the base. In addition to indicating the presence of a new remote, the CONNECT packets provide the current relationship between remote serial numbers and handles.

When a remote links to a base and requests registration, it is assigned an unused handle by the base. If the remote is the only or first radio registering with the base, it will be assigned handle 30H. When a remote leaves the coverage area of the base or otherwise loses link, e.g. the remote was turned off or put into sleep mode, the base detects this event when the remote does not renew its registration within 255 hops. With the default setting of 30msec per hop, this could be as long as 7.65 seconds. If within this time the remote re-establishes link with the base, the previous handle assigned to this remote will still be marked active in the base radio. Thus the remote will be assigned a new handle. If the base radio is in one of the protocol modes, a new CONNECT packet will be issued indicating the current handle assigned to the remote. The remote is identified by the serial number that is contained in the CONNECT packet.

If the radio is to be used in a point-to-point mode where there is only one base and one remote, using the point-to-point mode command of the radios will override this handle mechanism and always assign the remote the same handle.

2.2.4. TDMA Operation

In the WIT2411 TDMA scheme, the base station time slot is set independently of the remote time slots through the *Set Base Slot Size* command. The base divides the time remaining in the hop after subtracting for the base overhead, base slot size and guard bands between remote transmit slots into 26 equal-size remote transmit slots. These 26 transmit slots are allocated among remotes requesting transmit slots. Each remote that has data to send requests a transmit slot from the base radio. Based on the amount of data the remote has to send, the remote will request more or fewer transmit slots. Depending on the number of unused remote-to-base transmit slots, the base radio either will assign one or more slots or will not assign a slot. The remote will request slots on every hop that it has data to send. When it has no data to send, it indicates that to the base and any slots that have been assigned are freed for assignment to other remotes. Depending on the amount of activity of other remotes, the number of transmit slots assigned to a remote can vary from hop to hop even if the number requested does not change.

A typical sequence goes as follows: Data is sent to a remote radio by the remote host. During a contention time in the hop, the remote requests some number of transmit slots based on the amount of data it has to send. Up to three remotes can request time slots during a single contention period. On the next hop, the base radio assigns some transmit slots to the remote. On that same hop, the remote transmits as much data as will fit in the assigned time slots and request time slots for the next hop. The requests for time slots by remotes currently assigned time slots do not occur in the contention period and thus do not count against the three remotes that can request slots during this period. On the hop when the remote exhausts the data it has to send, the remote indicates to the base that it has no data to send. The base adds those slots back into the pool of unused slots. There are a total of 26 remote to base transmit slots. Thus a maximum of 26 remotes can be transmitting to the base on a single hop with each remote assigned a single slot. Remotes will be assigned as many slots as are available up to the number requested by the remote. A remote can request a maximum of 26 slots. The number of slots requested by a remote

is calculated by the remote based on the amount of data it has to send. The calculation is performed to send the data in as few hops as possible.

When setting up a network, keep in mind that time slot length, maximum packet size and hop duration are all interrelated. The *hop duration* parameter will determine the time slot size and the maximum amount of data that can be transmitted per hop by the remotes. The base station requires 1.7 ms overhead for tuning, the synchronization signal and parameter updating, as well as a guard time of 150 μ s between each remote slot. Thus the amount of time allocated per remote slot is roughly:

$$\frac{\text{hop duration} - \text{base slot} - 1.7\text{ms} - 25 \text{ transmit slot guard bands} \cdot 150\mu\text{s}}{26 \text{ remote transmit slots}}$$

For the default settings of base slot size of 160H and hop duration of 240H, the amount of data that can be transmitted by remotes per hop is calculated by:

The hop duration is set in 52.1 μ sec increments. Thus a hop duration of 240H becomes:

$$576 \times 52.1\mu\text{sec} = 30\text{msec}$$

The base slot size is set in increments of 8 bytes. A base slot size of 160H is:

$$160\text{H} = 352 \text{ Decimal} \times 8\text{bytes} = 2,816 \text{ bytes}$$

With a 1,228,800 bps data rate, the time it takes to transmit 2,816 bytes of data is:

$$2,816 \text{ bytes} \times 8\text{bits per byte} / 1228800\text{bps} = 18.3\text{msec}$$

Adding the 1.7msec of base overhead gives a total base time of:

$$18.3\text{msec} + 1.7 = 20.0\text{msec}$$

Subtracting the guard band time of 25 x 150 μ sec or 3.75msec leaves

$$30\text{msec} - 20.0\text{msec} - 3.75\text{msec} = 6.25\text{msec}$$

Dividing this time by 26 slots yields a remote transmit slot time of

$$6.25\text{msec} / 26 \text{ slots} = 0.240\text{msec per slot}$$

Converting that time to bytes of data yields:

$$0.240\text{msec} \times 1228800\text{bps} / 8\text{bits/byte} = 36 \text{ bytes per slot}$$

This corresponds to the base sending just over 750Kbps and the aggregate of the remote throughput equaling about 250Kbps. This is clearly setup for predominantly base to remote transmission. The balance between base and remote transmission is varied using the *Set Base Slot Size* and *Set Hop Duration* commands. Details of these commands are provided in the *Modem Commands* section of this manual.

It is often difficult to predict what throughput a remote will obtain in a point-to-multipoint network. The worst-case scenario would be when there are 26 remotes transmitting continuously. In this case, each remote would get 1/26th of the remote to base aggregate throughput of about 250Kbps or about 9600bps. In practice, given the

over-the-air data rate of the radio (1.2288Mbps) is faster than the serial input to the radio (921.6Kbps), it is rare that this circumstance will exist more than briefly. Also, in applications where there are more remotes to base communication than base to remotes, the base slot size will be reduced accordingly. These calculations are provided as a means of only estimating the capacity of a multipoint WIT2411 network.

2.2.5. Full Duplex Communication

From an application perspective, the WIT2411 communicates in full duplex. That is, both the user application and the remote terminal can be transmitting data without waiting for the other to finish. At the radio level, the base station and remotes do not actually transmit at the same time but rather use a Time Division Duplex (TDD) scheme. As discussed earlier, the base station transmits a synchronization signal at the beginning of each hop followed by a packet of data. After the base station transmission, the remotes will transmit. Each base station and remote transmission may be just part of a complete transmission from the user application or the remote terminal. Thus, from an application perspective, the radios are communicating in full duplex mode since the base station will receive data from a remote before completing a transmission to the remote.

2.2.6. Error-free Packet Transmission Using ARQ

The radio medium is a hostile environment for data transmission. In a typical office or factory environment, 1% - 2% of the 2.4GHz frequency band may be unusable at any given time at any given station due to noise, interference or multipath fading. For narrowband radio systems (and also many spread spectrum radio systems which use direct sequence spreading), this would imply a loss of contact on average of over 30 seconds per hour per station. The WIT2411 overcomes this problem by hopping rapidly throughout the band in a pseudo-random pattern. If a message fails to get through on a particular channel, the WIT2411 simply tries again on the next channel. Even if two thirds of the band is unusable, the WIT2411 can still communicate reliably.

Data input to the WIT2411 is broken up by the radio into packets. A 24-bit checksum is attached to each packet to verify that it was correctly received. If the packet is received correctly, the receiving station sends an acknowledgment, or **ACK**, back to the transmitting station. If the transmitter doesn't receive an **ACK**, at the next frequency hop it will attempt to send the packet again. When ARQ is enabled, the transmitting radio will attempt to send a packet *packet attempts limit* times before discarding the packet. A value of **00H** disables ARQ. When it is disabled, any transmission received with errors is discarded. It is the responsibility of the user application to track missing packets. A second parameter, *ARQ Mode*, allows the choice between using ARQ to resend unsuccessful transmissions or always sending a transmission *packet attempts limit* times regardless of the success or failure of any given transmission.

All of this error detection and correction is transparent to the user application. All the user application sees is error-free data from the modem. However, if the ARQ mode is

disabled, transmissions with errors are discarded, and missing data detection will be the responsibility of the user application. Refer to the *Protocol Commands* section for complete details.

2.3. Modes of Operation

2.3.1. Control and Data Modes

The WIT2411 has two modes of operation: Control mode and Data mode. When in Control Mode, the various radio and modem parameters can be modified. When in Data Mode, only data can be transmitted. The default mode is Data Mode. There are two ways to enter Control Mode. The first way is to assert the Configure (CFG) pin on the modem. Upon entering Control Mode, the modem will respond with a > prompt. After each command is entered, the modem will echo the value just entered and again respond with a > prompt. As long as the CFG pin is asserted, data sent to the modem will be interpreted as command data. Once the CFG pin is de-asserted, the modem will return to Data Mode.

The second method for entering Control Mode is to send the escape sequence `:wit2411` (all lower case) followed by a carriage return. In the default mode, the escape sequence is only valid immediately after power up or after de-assertion of the Sleep pin on the modem. The modem will respond in the same way with a > prompt. To return to Data Mode, enter the *Exit Modem Control Mode* command, `z>`, or assert and then de-assert the Sleep pin. There are three modes for the escape sequence, controlled by the *Set Escape Sequence Mode* command, `zc`:

- `zc = 0` Escape sequence disabled
- `zc = 1` Escape sequence available once at startup
- `zc = 2` Escape sequence available at any time (default setting)

The `zc2` mode setting is useful if the user application has a need to change the modem settings "on the fly". In this mode the escape sequence is always enabled and may be sent at any time after a pause of at least two hop dwell times. The modem will respond in the same way as when in the default mode. It is necessary to issue the *Exit Modem Control Mode* command, `z>`, before resuming data transmission. The escape sequence must be interpreted as data until the last character is received and as such may be transmitted by the modem to any listening modems.

2.3.2. Sleep Mode

To save power consumption for intermittent transmit applications, the WIT2411 supports a Sleep Mode. Sleep Mode is entered by asserting the Sleep pin on the modem interface. While in Sleep Mode, the modem consumes less than 50 μ A. This mode allows the radio to be powered off while the remote device remains powered. After leaving Sleep Mode, the radio must re-synchronize with the base station and re-register.

2.3.4. RF Flow Control Mode

Because of slight differences in baud rates between transmitting and receiving hosts, when sending large amounts of data (100's of KB) in one direction in a point-to-point application, it is possible to overrun the receive buffer of the receiving radio. For example a nominal 115.2Kbaud at the transmitting radio's host might really be 115,201 and at the receiving radio's host it might be 115,199. This is similar to a situation where the transmitting radio is sent data at a higher baud rate than the baud rate at which data is received by the receiving host. To compensate for the variations in nominal baud rates, the WIT2411 supports an RF flow control mode for point-to-point operation. In this mode, when the receive buffer of the receiving WIT2411 is close to full, the receiving WIT2411 stops acknowledging transmissions. The transmitting radio is set to infinite retries which invokes the RF flow control mode (See *Set Packet Attempts Limit* in Section 5.3). The receiving radio will not begin acknowledging transmissions from the transmitting radio until more room in the receive buffer has become available. This will cause data in the transmit buffer of the transmitting radio to back up. If it backs up to the point where the transmit buffer fills up, the transmitting radio will de-assert CTS stopping data from the transmitting radio's host device. Once room is available in the receiving radio's buffer, the receiving radio will begin acknowledging transmissions from the transmitting radio allowing the transmitting radio's buffer to begin to empty which will cause the transmitting radio to reassert CTS. Either one or both of the radios in a point-to-point installation can be configured for the RF flow control. If this mode is invoked in a point-to-multipoint installation, communications with all radios will be stopped when any one radio's receive buffer becomes full.

3. PROTOCOL MODES

In point-to-point applications, it is generally desired that the radios operate in a transparent mode. That is, raw unformatted data is sent from the host to the radio and is received as raw data at the receiving end. The addressing and error detection and correction are still performed by the radios, but it is transparent to the user application. To set up a point-to-point network, one radio has to be set up as a base station. When the radios are powered on, the base station will send out the synchronization signal at the beginning of each hop. The remote will synchronize with the base and automatically request registration. Once the remote is registered, the radios can transmit data. Protocol mode operation is available in point-to-point mode if desired.

If the base station is to be responsible for directing data to a specific remote in point-to-multipoint mode, the data sent to the base station by the user application must adhere to a packet format. This allows transmissions from the base station to be directed to a specific remote. Data received by a base station from a remote is similarly formatted to identify to the user application the remote that sent the transmission. The remotes may still use transparent mode without formatting to send data to the base, if desired. The WIT2411 protocol format is described in detail below. The protocol format is selected through the *Set Protocol Mode* command.

Base radios can use protocol modes to insure that a packet is transmitted to the base without being broken up over multiple hops. Note that if the *data length* is set to a number of bytes longer than the number of bytes that can be transmitted by a base on a single hop, the packet will be discarded. For the base, this value is set by the *Set Base Slot Size* command. A packet will not be transmitted until the entire packet has been sent to the radio, regardless of the amount of time it takes.

If the remote hosts can determine what data is directed to them in point-to-multipoint mode, the data can be sent to the base station without using a packet format. In this situation, broadcast mode is selected at the base station by using the *Set Default Handle* and selecting **3FH** as the default handle. In this mode, the automatic retransmission of unsuccessful transmissions is disabled. This is required since all of the remote modems will attempt to acknowledge each base transmission when ARQ is enabled. Transmissions that are received with errors are discarded by the radio. The remote devices must be able to detect a missing packet and request a retransmission by the base device.

Protocol Modes Definitions

mode 00 Transparent mode used for point-to-point networks or multipoint remotes; does not support any packet types.

mode 03 This mode includes notification when remotes are registered or dropped through CONNECT and DISCONNECT packets that are sent to the user application at the base station and at the remote. No sequence numbers are provided.

packet types supported: Data
 CONNECT
 DISCONNECT

3.1. Packet Formats

The byte formats for each packet type are shown in the table below. Packet fields are organized to fall on byte boundaries. In the case of bit-level fields, most-significant bits are on the left.

WIT2411 packet types (mode-03):

		Transmit and Receive:												
Base	DATA	1110	1001	1100	0101	00HH	HHHH	00SS	SSSS	LLLL	LLLL	LLLL	LLLL	<0-65536 bytes data>
Remote	DATA	1110	1001	1100	0101	0000	0000	00SS	SSSS	LLLL	LLLL	LLLL	LLLL	<0-65536 bytes data>
		Receive only:												
	CONNECT	1110	1001	1100	0101	10HH	HHHH	RRRR	TTTT	00NN	NNNN			<3 byte remote ID>
	DISCONNECT	1110	1001	1100	0101	11HH	HHHH	0111	1111					
	H	: handle number (0-63)												
	S	: packet sequence number (0-63)												
	L	: data length (0-65536)												
	N	: remote's previous network number (if roamed)												
	R	: receive sequence number (from previous cell)												
	T	: transmit sequence number (from previous cell)												

Note that while the packet length can be set to 65536, the maximum number of bytes transmitted per hop is limited to the lesser of 65536 or the length specified by maximum data length. Packets with a data length longer than that will be discarded and not sent. See Get Maximum Data Length for more details.

Handle 63 (3FH) is reserved for broadcast packets from the base to all remotes. Acknowledgment requests are not supported for broadcasts. For this reason, it is a good

idea to send broadcast messages several times to increase the odds of reaching all remotes.

3.1.3. Connect Packet

```
1110 1001 1100 0101  10HH HHHH   RRRR TTTT   00NN NNNN   <3-byte remote ID> (base, receive only)
```

```

H       : handle number (0-62)
R       : receive sequence number (from previous cell)
T       : transmit sequence number (from previous cell)
N       : network number of the previous base (if roamed)

```

```
1110 1001 1100 0101 10HH HHHH   RRRR TTTT   00NN NNNN   <3-byte base ID> (remote, receive only)
```

```

H       : handle number (0-62)
R       : receive sequence number
T       : transmit sequence number
N       : network number of base

```

Remotes must go through an automatic registration process when roaming from one base to another, after loss of contact, or when acquiring a base signal for the first time after power up. The base then assigns the remote a handle value, may or may not assign it a dedicated time slice depending on the user settings, and notifies the user application of the new remote with a connect packet.

The network number of the last base the remote was connected to is given to aid user software in resending orphan packets that may have been sent to the remote's previous cell. If the remote has been powered up for the first time and this is the first base contacted, the last base ID will be reported as 80H.

3.1.4. Disconnect Packet (base only, receive only)

```
1110 1001 1100 0101 11HH HHHH   0111 1111
```

```

H       : handle number (1-62)

```

When a remote goes out of range or roams to another cell, the base issues a disconnect packet to indicate that the remote is no longer available.

4. MODEM INTERFACE

Electrical connection to the WIT2411 is made through a 16-pin male header on the modem module. The signals are 3.3 volt signals and form an RS-232 style asynchronous serial interface. The table below provides the connector pinout.

Pin	Signal	Type	Description
1	GND	-	Signal and chassis ground
2	TXD	Input	Transmit data. Input for serial data to be transmitted. In Control Mode also used to transmit modem commands to the modem.
3	RXD	Output	Receive data. Output for received serial data. In Control Mode, also carries receive modem status from the modem.
4	$\overline{\text{CFG}}$	Input	Configuration selector. Used to switch between Control and Data Modes. Normally, CFG will be set for Data Mode. An internal 10K pull-up enables Data Mode if this signal is left unconnected. Control Mode is also accessible by transmitting an escape sequence immediately after wake up or power up. (0v) 1 = Control Mode (3.3v) 0 = Data Mode
5	$\overline{\text{RTS}}$	Input	Request to send. Gates the flow of receive data from the radio to the user on or off. In normal operation this signal should be asserted. When negated, the WIT2411 buffers receive data until RTS is asserted. (0v) 1 = Receive data (RxD) enabled (3.3v) 0 = Receive data (RxD) disabled.
6	SLEEP	Input	Sleeps/wakes radio transceiver. In sleep mode all radio functions are disabled consuming less than 50 μ A. At wake up, any user programmed configuration settings are refreshed from non-volatile memory, clearing any temporary settings that may have been set. (3.3v) 1 = Sleep Radio (0v) 0 = Wake Radio
7	$\overline{\text{DCD}}$	Output	Data carrier detect. For remotes, indicates the remote has successfully acquired the hopping pattern of the base station. (0v) 1 = Carrier detected (synchronized) (3.3v) 0 = No carrier detected (not synchronized)
8	$\overline{\text{CTS}}$	Output	Clear to send. Used to control transmit flow from the user to the radio. (0v) 1 = Transmit buffer not full, continue transmitting (3.3v) 0 = Transmit buffer full, stop transmitting
9	-	-	Reserved for future use. Do not connect.
10	$\overline{\text{Reset}}$	Input	Resets the radio.
11-15	-	-	Reserved for future use. Do not connect.
16	VCC	-	Positive supply. Min 3.3 v, 5.0 v nominal, 10.0 v max.

4.1. Interfacing to 5 Volt Systems

The modem interface signals on the WIT2411 are 3.3 volt signals. To interface to 5 volt signals, the resistor divider network shown below must be placed between the 5 volt signal outputs and the WIT2411 signal inputs. The output voltage swing of the WIT2411 3.3 volt signals is sufficient to drive 5 volt logic inputs.

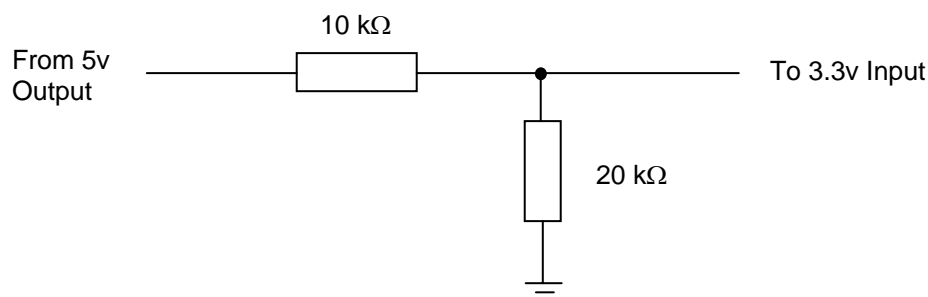

4.2. Evaluation Unit and Module Differences

The evaluation unit has an RS-232 transceiver that translates RS-232 level signals to 3.3 volt signals for input into the OEM module inside the evaluation unit. A typical schematic is shown in Appendix 7.5. The OEM module does not have any type of RS-232 transceiver and cannot handle the RS-232 voltages. This allows the OEM module to be easily integrated into any 3.3 volt system without any logic signal translation. In order for the OEM module to function properly several pins need to be driven low or tied to ground. Pin 5 (RTS) and pin 6 (SLEEP) need to be pulled to ground on the 16-pin male header. If you have the OEM module interfaced to an RS-232 transceiver, RTS and DTR need to be pulled high on the transceiver side. In the evaluation unit, RTS and DTR are pulled high on the transceiver side so the evaluation unit will work with these signals not connected.

4.3. Three-Wire Operation

The WIT2411 can be operated in a three-wire configuration using just TxD, RxD and Ground. To operate the WIT2411 in this configuration, the Sleep and RTS signals must be tied to ground. These signals are pulled up on the WIT2411 module and if left disconnected will put the radio into sleep mode and RTS will be de-asserted.

The WIT2411 does not support software flow control (XON/XOFF). Thus when using a three wire configuration, there is no flow control. The radio configuration and/or the application must insure the transmit and receive buffers do not overflow. The WIT2411 has a 2048-byte transmit buffer and a 1024-byte receive buffer.

5. MODEM COMMANDS

The WIT2411 is configured and controlled through a series of commands. These commands are sent to the modem directly when the modem is in Control Mode when the modem is in Data Mode if the escape sequence is enabled. The command syntax is the same for either method, a one- or two-letter command followed by one or more parameters. The modem will respond with a two-byte message that indicates the new modem parameter value. The commands are loosely grouped into five different categories: Serial commands, Network commands, Protocol commands, Status commands and Memory commands. Each command is described in detail below. In the descriptions, brackets ([,]) are used to denote a set of optional arguments. Vertical slashes (/) separate selections. For example, given the string `wn[?|0..3f]`, some legal commands are `wn?`, `wn0`, `wn3` and `wna`. Most commands which set a parameter also have a `?` option which causes the modem to respond with the current parameter setting, e.g., `wn?`. Each modem command must be followed by either a carriage return or a line feed.

5.1. Serial Commands

These commands affect the serial interface between the modem and the host. The default settings are 115,200 bps and protocol mode 0.

Command	Description
<code>sd[? 01 0f]</code>	Set Data Rate Divisor Data Rate Divisor (hex) 115200 bps = 0f (default) 921600 bps = 01
<code>sp[? 00 03]</code>	Set Protocol Mode (currently only mode 3 is working) 00 = point-to-point transparent mode 03 = command, data and connection notification

Set Data Rate Divisor

Sets the serial bit rate between the modem and the host. This command takes effect immediately and will require adjusting the host serial rate to agree.

Set Protocol Mode

Enables the base station to operate in a multipoint network. Depending on the user application, more or less acknowledgment may be desired by the application. Remotes can operate in transparent mode even though the base station is operating in one of the nontransparent modes.

When using a protocol mode, make sure to count in packet overhead when calculating network performance. Refer to the section on *Protocol Modes* for details on each format.

5.2. Network Commands

Network commands are used to set up a WIT2411 network and to set radio addressing and configuration.

Command	Description
wb[? 0 1]	Set Transceiver Mode 0 = remote (default) 1 = base station
wg[? 0 1]	Enable Global Network Mode (remote) 0 = Link only to hop pattern specified by wn parameter (default) 1 = Link to any hop pattern, regardless of wn parameter
wl[? 0-ff]	Set lockout key allowing network segregation beyond network number 0 = default
wn[? 0-3f]	Set Hopping Pattern (Network Number) 0 = default
wp[? 0 1]	Set Transmit Power 0 = 10mW 1 = 100mW (default)
wu[? 0 1]	Set Point-to-Point Direct Mode 0 = Multipoint mode (default) 1 = Point-to-point direct mode

Set Transceiver Mode

Sets modem operation as either base station or remote. Default is remote.

Enable Global Network Mode

For networks with multiple base stations, remotes are ordinarily only able to link to one base station, set by the hopping pattern. Mode 1 enables the global mode that allows remotes to link to any base station they can hear, acquiring whatever hop pattern is required. In this mode a remote can only change base stations once it is no longer registered with a base station.

Set Lockout Key

Allows further network segregation beyond the network number. This feature allows multiple co-located networks in which global roaming or seamless roaming is enabled. In global and seamless roaming, a remote is allowed to link to any base regardless of the network number as long as the lockout key agrees. By using different lockout keys, the bases to which remotes link can be limited or segregated.

Set Hopping Pattern

The WIT2411 has 64 preprogrammed hopping patterns (also referred to as network numbers). By using different hopping patterns, nearby or co-located networks can avoid interfering with each other's transmissions. Even if both networks tried to use the same frequency, on the next hop they would be at different frequencies.

Set Transmit Power

The WIT2411 has two preset transmit power levels, 10mW (10dBm) and 100mW (20dBm). Control of the transmit power is provided through this command. Default is 100mW.

Set Point-to-Point Direct Mode

Sets point-to-point mode that is recommended for point-to-point applications, especially where the remote radio is mobile and may leave and re-enter the range of the base. This mode fixes the remote handle assignment to always be 30H and improves the re-registration process. Must be set in both base and remote radios.

5.3. Protocol Commands

These commands can be used to tune the transceiver for optimum transmission of data across the RF link. For most applications, the default values are adequate.

Command	Description
pe[? 0-9]	Set Alternative Frequency Band 0 = FCC/ETSI operation. (~2401 – 2471MHz) (default) 1 = Avoids 802.11b bands 1 & 2 2 = Avoids 802.11b bands 3 & 4 3 = Avoids 802.11b bands 5 & 6 4 = Avoids 802.11b bands 7 & 8 5 = Avoids 802.11b bands 9 & 10 6 = Avoids 802.11b bands 11 & 12 7 = Reserved 8 = Israel (~2418 – 2457MHz) 9 = Mexico/Canada (~2450 – 2483.5MHz)
xh[? 00-ff] (base only)	Set high byte of Hop Duration 02H = default
ph[? 00-ff] (base only)	Set low byte of Hop Duration 40H = default
pr[? 00-ff]	Set Packet Attempts Limit 10H = default FFH = Infinite retry (RF flow control point-to-point only)
xw[? 00-34] (base only)	Set high byte of Base Slot Size 01H = default
pw[? 00-34] (base only)	Set low byte of Base Slot Size 60H = default
px[? 0 1]	Set ARQ mode. 0 = ARQ enabled (default) 1 = ARQ disabled (redundant transmission)

Note: Incorrect setting of these parameters may result in reduced throughput or loss of data packets.

Set Alternative Frequency Band

When set to a value between 1 and 6, will cause the WIT2411 to hop around the various 802.11b channels. When used in this mode, the WIT2411 will not interfere with co-located 802.11b systems. This mode of operation is allowed by the FCC in the United States and the ETS in Europe. For Mexico and Canadian operation, set this parameter to 4.

Set Hop Duration

Sets the length of time the transceiver spends on each frequency channel. A smaller value will allow the remote to lock on to the base signal faster at system startup, and will generally decrease packet latency. A larger value increases network capacity, due to decreased overhead in channel switching. The hop duration is specified in 52.1 μ s increments. The default value of **240H** corresponds to a duration of 30ms. For best results, do not specify a duration of less than 3 ms. This value only needs to be set in the base which broadcasts the parameter to all remotes. However, link time can be reduced if this value is also programmed into the remotes, which use it as a starting value when scanning for the base.

Set Packet Attempts Limit

If *ARQ Mode* is set to 0, sets the number of times the radio will attempt to send an unsuccessful transmission before discarding it. If *ARQ Mode* is set to 1, it is the number of times every transmission will be sent, regardless of success or failure of a given attempt. When this parameter is set to **FFH**, RF flow control mode is entered for transmissions from the radio (See Section 2.3.4). This mode can be entered for one or both radios in a point-to-point system. When used in a point-to-point system the **wu** parameter should be set to 1. Using this mode in a point-to-multipoint system will stop transmissions to all radios when any one radio has a full buffer or if the base radio attempts to send data to a remote that has recently (<2.5 seconds) left the range of the base.

Set Base Slot Size (base station only)

Sets the amount of time allocated for transmission on each hop for the base station time slot in 52.1 μ s increments, corresponding to 8 bytes per unit. Default value is **160H** which corresponds to 2,816 bytes. If using a protocol mode, attempting to send a packet with a length longer than this setting will cause the packet to be discarded.

Set ARQ Mode

Sets ARQ mode when set to 0 which is the default. In this mode the radio will resend an unsuccessful transmission until either successful or *packet attempt limit* attempts have been made. When set to 1 selects redundant transmit mode that will send every transmission *packet attempt limit* times regardless of success or failure of any given attempt. When redundant transmit mode is used, receiving radios will discard all subsequent retransmissions once the transmission has been successfully received. Thus the receiving host will receive just one copy of the transmission.

5.4. Status Commands

These commands deal with general interface aspects of the operation of the WIT2411.

Command	Description
zb[? 0 1]	Banner Display Disable 0 = disabled 1 = enabled (default)
zc[? 0..2]	Set Escape Sequence Mode 0 = disabled 1 = once after reset 2 = unlimited times (default)
zh?	Read factory serial number high byte.
zm?	Read factory serial number middle byte.
zl?	Read factory serial number low byte.
z>	Exit Modem Control Mode

Banner Display Disable

Enables or disables display of the banner string and revision code automatically at power-up. May be disabled to avoid being mistaken for data by the host.

Set Escape Sequence Mode

Enables or disables the ability to use the in-data-stream escape sequence method of accessing Control Mode by transmitting the string ":WIT2411". When this mode is set to 1, the escape sequence only works immediately after reset. When set to 2, the escape sequence may be used at any time in the data stream when preceded by a pause of two hop dwell times (this is the default). For backwards compatibility with the WIT2400, the string ":wit2400" is also accepted for entering Control Mode. Note that the escape sequence must be interpreted as data by the radio until the last character is received, and as such will be generally be transmitted to a receiving radio station, if any.

Read Factory Serial Number High, Middle and Low Bytes.

These read only commands return one of the three bytes of the unique factory-set serial number, which are also visible in the startup banner.

5.5. Memory Commands

The WIT2411 allows the user to store a configuration in nonvolatile memory, which is loaded during the initialization period every time the radio is powered up. Note that changes to the serial port baud rate from recalling the factory defaults or recalling memory will not take effect until DTR is toggled or power to the radio is cycled.

Command	Description
m0	Recall Factory Defaults
m<	Recall Memory
m>	Store Memory
m!	Display Modified Parameters

Recall Factory Defaults

Resets the WIT2411 to its factory default state. This is useful for testing purposes or if there is a problem in operation of the system and the configuration is suspect. Use the *Store Memory* command afterwards if you wish the factory default settings to be remembered the next time you cycle power or reset the radio.

Recall Memory

Useful for restoring the power-on settings after experimenting with temporary changes to data rate, protocol or network parameters, etc.

Store Memory

This command is necessary after any command to change the data rate, transceiver address, or other radio setting that you wish to make permanent.

Display Modified Parameters

This command lists all parameter settings that are different from the factory default settings. This will list changed parameters whether or not they have been stored with the m> command. Note that issuing this command will cause the radio to lose link with the base and will cause all remotes to lose link when issued to the base radio.

5.6. Modem Command Summary

Serial Commands

sd[? 1 f]	Set Data Rate Divisor
sp[? 0 3]	Set Protocol Mode (only 0 and 3)

Network Commands

wb[? 0 1]	Set Transceiver Mode
wl[? 0..ff]	Set Lockout Key
wn[? 00..3f]	Set Hopping Pattern
wg[? 0 1]	Enable Global Network Modes
wp[? 0 1]	Set Transmit Power
wu[? 0 1]	Set Point-to-Point Direct Mode

Protocol Commands

pe[? 0..9]	Set Alternative Frequency Band	(base only)
xh,ph[? 00..ff]	Set Hop Duration	(base only)
pr[? 00..ff]	Set Packet Attempts Limit	
xw,pw[? 00..ff]	Set Base Slot Size	(base only)
px[? 0 1]	Set ARQ Mode	

Status Commands

zb[? 0 1]	Banner Display Disable
zc[? 0..2]	Set Escape Sequence Mode
zh?	Read Factory Serial Number High Byte
zm?	Read Factory Serial Number Middle Byte
zl?	Read Factory Serial Number Low Byte
z>	Exit Modem Control Mode

Memory Commands

m0	Recall Factory Defaults
m<	Recall Memory
m>	Store Memory
m!	Display Changed Parameters

Note: Brackets ([,]) as used here denote a set of optional arguments. Vertical slashes separate selections. For example, given the string wn[?|00..3f], legal commands would be wn?, wn0, wn3, and wn2a. Most commands which set a parameter also have a ? option which displays the current parameter setting; e.g., wn?.

6. WIT2411 DEVELOPER'S KIT

The WIT2411 Developer's Kit contains two self-contained wireless modems (HN-511s) built around the WIT2411M OEM module. In addition, two WIT2411M OEM modules are included in the kit. The self-contained units allow developers to get up and running quickly using standard RS-232 or USB interfaces without having to build a CMOS level serial interface. In addition, the self-contained modems include status LEDs to provide modem status information visually. The built-in battery pack allows the developer to use the modems without being tethered to a power source. This provides a simple way to test the range of the radios. Other than the true RS-232 level signals of the serial interface and the USB interface, the self-contained modems operate exactly as the OEM modules.

The HN-511 will communicate over the USB port if that port is connected to an active USB device. Otherwise, it will communicate of the RS-232 serial port.

Connection is made to the USB port using the standard USB cable provided. The USB port is provided to simplify communicating to the WIT2411 module in the HN-511 at the 921,600 bps data rate. While most PCs can support that data rate through a USB port, they are unable to do so through a standard RS-232 port.

When the HN-511 is powered up and connected to a USB port on the computer, you will be notified that a new device has been found and will be prompted for the location where the driver is to be found. Click on the Have Disk button and insert the CD included in the developer's kit. Select the drive letter of the CD drive and click continue. The USB drivers will be installed automatically.

Connection is made to the RS-232 port of HN-511s through a standard DB-9 connector. The HN-511s are set up as DCE devices requiring the use of a straight-through cable to connect to DTE devices. The pinout is provided in Section 7.3. The modems can be used with just a three-wire connection. Transmit data, receive data and ground are the three required connections. Note that in this configuration, no flow control is available as the WIT2411 does not support software flow control.

When the developer's kit is shipped from the factory, one HN-511 is set up as a base station and the other is set up as a remote. The interface rate for both modems is set at 115,200 bps. The default settings allow the modems to communicate without changing any settings. As a quick test, separate the two modems by about 5 feet, plug in the power and turn the modems on. Do not connect the modems to any device. The Carrier Detect (CD) LED on the base station will come on immediately. After a few seconds, the CD LED on the remote will come on. This indicates that the modems have synchronized and have established a communications link.

An important point to remember is that if the base station is in Sleep mode, no communications can take place until (1) the base station is taken out of sleep mode and (2) the remote has synchronized with the base station. As the Sleep signal is brought out on the pin usually occupied by DTR, connecting the base station to a PC serial port with

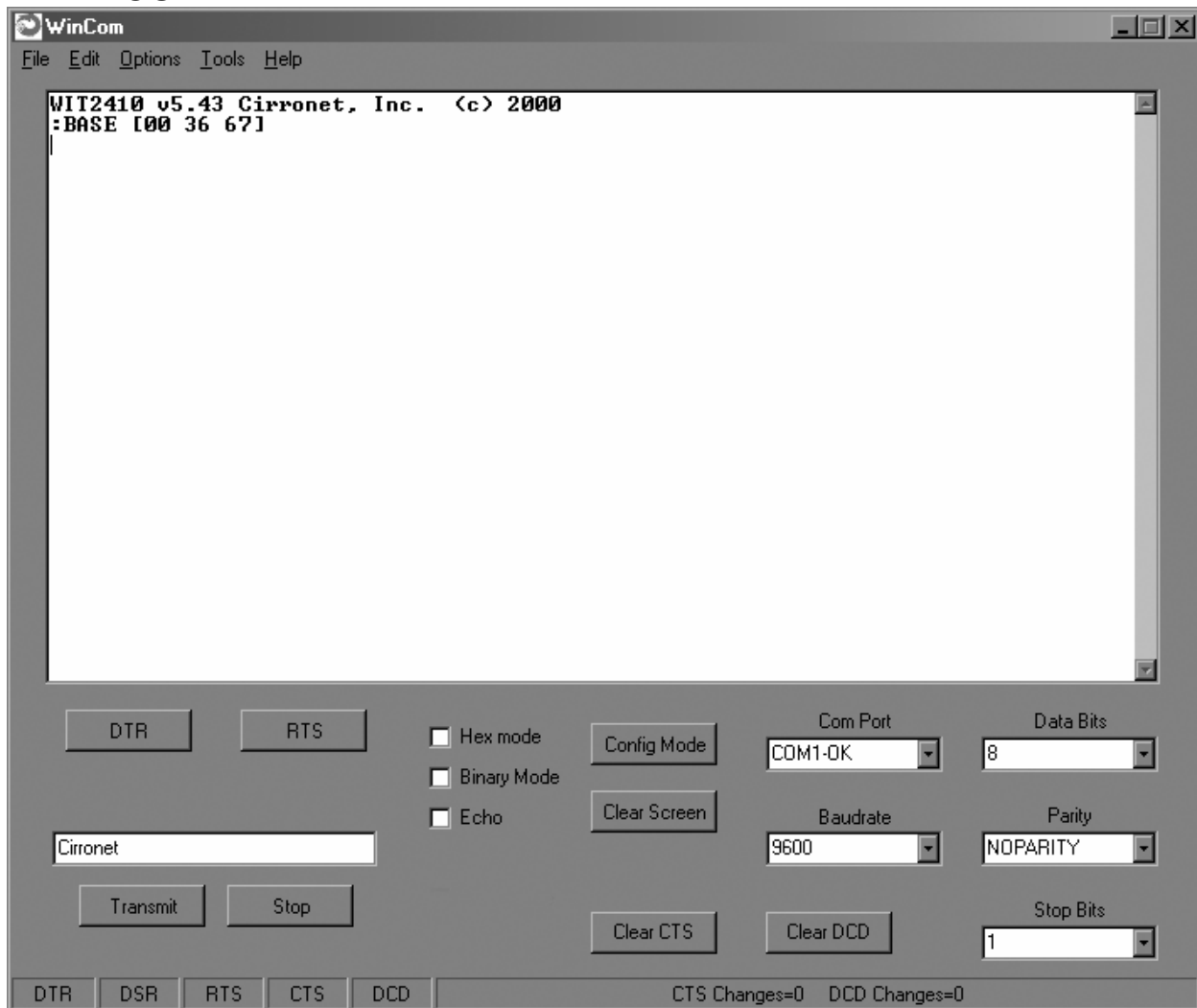

DTR de-asserted will put the modem into sleep mode. Some communications programs will attempt to communicate immediately after asserting DTR. The base station will transmit this data, but the remote will not be synchronized with the base station and will not receive the transmission. In this instance, do not connect the Sleep signal to DTR of the serial port.

7. WinCOM

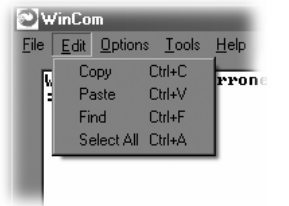
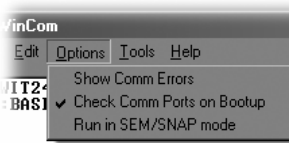
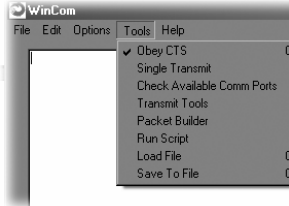

Provided with the developer's kit is a configuration program designed especially for Cirronet's wireless industrial transceivers or WIT radios. WinCOM is located on the Manuals and Software CD included in the developer's kit. Install WinCOM by navigating to the Software Tools directory on the Manuals and Software CD and double-click on wincom2.1.exe follow the installation wizard. Once it has installed, open WinCOM by double-clicking on the WinCOM icon on the desktop.

WinCom's menu structure is typical of Windows conventions with File, Edit, Options, Tools and Help selections.

 <p>A screenshot of the WinCom application window with the File menu open. The menu items are: Save Settings (Ctrl+S), Print (Ctrl+P), and Exit.</p>	<p>Under File, Save Settings (Ctrl S) saves the current WinCom settings to the hard drive, Print (Ctrl P) sends whatever text is in the display field to the printer and Exit terminates the program.</p>
 <p>A screenshot of the WinCom application window with the Edit menu open. The menu items are: Copy (Ctrl+C), Paste (Ctrl+V), Find (Ctrl+F), and Select All (Ctrl+A).</p>	<p>Under Edit, Copy, Paste, Find (search) and Select All perform the familiar Windows functionality in typical fashion.</p>
 <p>A screenshot of the WinCom application window with the Options menu open. The menu items are: Show Comm Errors, Check Comm Ports on Bootup (checked), and Run in SEM/SNAP mode.</p>	<p>The Options menu contains the selections, Show Comm Errors which lists any errors encountered in the PC UART. Check Comm Ports on Bootup tells WinCom to verify each available port and lists them as such in the Com Port drop down field.</p>
 <p>A screenshot of the WinCom application window with the Tools menu open. The menu items are: Obey CTS (checked), Single Transmit (Ctrl+D), Check Available Comm Ports, Transmit Tools, Packet Builder, Run Script, Load File (Ctrl+L), and Save To File (Ctrl+S).</p>	<p>See the section entitled WinCom Tools for an explanation of this drop down.</p>
 <p>A screenshot of the WinCom application window with the Help menu open. The menu item is: About.</p>	<p>The Help menu displays the About screen which lists the version number, hardware and software information for the system being used.</p>

7.1. Starting the program

When started, WinCOM de-asserts and re-asserts the DTR line to the radio which resets the radio causing the sign-on banner to be displayed. If the baud rate on the computer doesn't match the baud rate of the radio, illegible characters will be displayed. By hitting the PgUp or PgDn key to change the baud rate, then pressing F1 twice to toggle DTR (resets the radio) and causes a new banner to be displayed. Continue changing baud rates in this fashion until a legible banner is displayed as shown below.

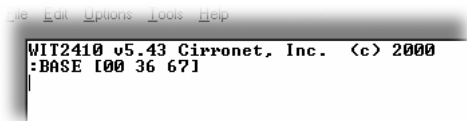

```

File Edit Options Tools Help
WIT2410 v5.43 Cirronet, Inc. (c) 2000
:BASE 100 36 671

```

The banner indicates the radio firmware version, whether the radio is operating as a base or a remote and the unique factory serial number of the radio module. If nothing is displayed in the communications window of WinCOM, verify the COM port and baud rate settings, then reset the radio (by hitting F1 twice). Cycling power to the radio also will cause the sign on banner to be displayed unless the banner is disabled via the Banner Display Disable command (**zbo**).

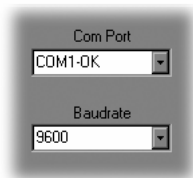

The COM port and baud rate can be changed using the drop down menus on the bottom right. All the available COM ports will be listed in the menu but will have OK or N/A designated. If another program that uses a COM port is open, that COM port will not be available for use by WinCOM.



The boxes on the lower right of the WinCOM window provide the status of the COM port flow control being used to communicate with the radio. Note that DCD is only asserted by radios configured as remotes when they are linked to a base radio. Radios configured as bases always assert DCD even if no remotes are linked. Clicking on the DTR or RTS buttons will change the state of the respective signal line in the COM port.

The radio is normally in data mode – data that is sent to it from the PC is transmitted over the wireless connection. When the WinCOM window is active, keys typed on the keyboard will be sent to the radio and will be transmitted. Unless the “Echo” box is checked the typed data will not be displayed in the WinCOM window of the sending radio.

To change configuration parameters, the radio must be put into configuration mode by clicking on the Config Mode button on the WinCOM window immediately after opening WinCOM or after cycling power to the radio. Another method is to toggle the DTR by pressing the F1 key twice, which de-asserts then re-asserts DTR, then pressing the F3 key (or Config Mode button).

```

WIT2410 v5.43 Cirronet, Inc. <c> 2004
:BASE [00 36 67]
>

```

When the radio is in configuration mode, a “>” prompt character is displayed in the WinCom window as shown above. Configuration parameters are sent to the radio by entering them in the WinCom window after the “>” prompt and pressing the Enter key.

```

:BASE [00 36 67]
WIT2410 v5.43 Cirronet, Inc. <c
:BASE [00 36 67]
> xd0
Error
>

```

If an invalid command or value is entered, the radio will respond with “Error” as shown above. Until the command to save the parameters (m>) is issued, the new parameters will only be valid until power is cycled or DTR is toggled by pressing the F1 key twice.

New parameter values that have been issued are saved to non-volatile memory using the “m>” command. Refer to the *Memory Commands* section for details on this and other helpful memory commands.

To exit configuration mode from the WinCom screen, use the “z>” command and press Enter as shown below.

```

WIT2410 v5.43 Cirronet, Inc. <
:BASE [00 36 67]
> m0
> z>

```

The return to the data mode is indicated by an absence of the “>” prompt. Refer to the *Configuration Commands* section below for details on all the configurable parameters.

When the radio is linked to another radio, a communications test can be run by clicking on the Transmit button or pressing the F6 key. Whatever ASCII string is in the Transmit String window will be transmitted as shown below.



If the other radio is sending data, the received data will be displayed in the WinCOM window.

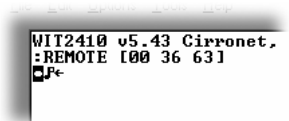

If the Binary box is checked, all characters received will be displayed subject to the limitations of Windows. For example, a carriage return will not return the cursor to the left side of the window but the character corresponding to 0x0d value of the carriage return will be displayed. Similarly, if the Hex Mode box is checked, all characters are displayed in hexadecimal format.

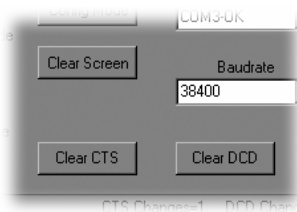

The Clear Screen button deletes all the text in the display window. The Clear CTS and Clear DCD buttons reset the respective changes counters to zero.

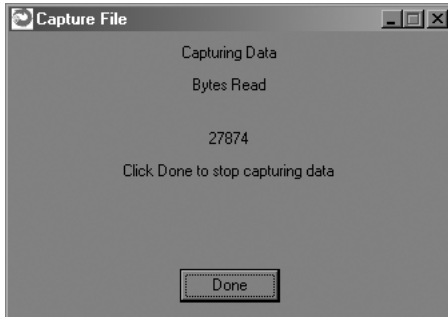

After naming the file and clicking on OK, the Capture Data window opens and shows the amount of data being received. Clicking on Done stops the loading of received data into the file.

7.2. Function Keys

All of the function key shortcuts are described below:

- F1** Toggles state of DTR (Sleep). State is shown in status line.
- F2** Toggles state of RTS. State is shown in status line.
- F3** Transmits “:wit2400”. Used to enter control mode.
- F5** Toggles local echo. If you are transmitting characters through one modem to another WIT2450, this allows you to see what you are typing.
- F6** Toggles stream mode. Causes WinCOM to transmit a repeating pattern of characters. Useful for testing.
- F8** Toggles binary mode. Displays extended ASCII and control characters. Useful for testing.
- PgUp** Sets data rate of PC serial port to next higher value. Value is displayed in status line. Useful when WinCOM is used to change the WIT2450 interface data rate. WinCOM can communicate at new data rate without having to exit and re-enter WinCOM.
- PgDn** Sets data rate of PC serial port to next lower value. Value is displayed in status line.

7.3. WinCom Tools

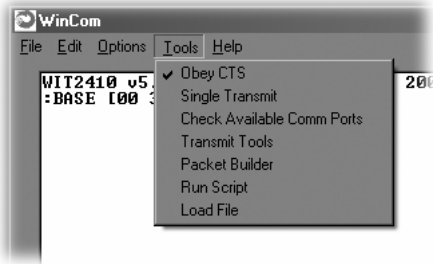

There are seven selections under the Tools menu. The first, Obey CTS is useful when just a three wire connection is made between the radio and the computer. Some PCs let the CTS input line float. If CTS is not asserted, the PC COM port will not send data.

Note: Unchecking this selection will have the PC COM port ignore the state of CTS and transmit data.

When WinCOM's transmit mode is used, data is sent continuously until the user stops it by clicking on Stop or pressing F6. If the second tool, Single Transmit, is checked, clicking the Transmit button will send the Transmit String a single time. There is no need to click Stop. Clicking on the Transmit button a second time will have the string transmitted a second time.

The third allows for checking of available Comm Ports and is useful for refreshing the list.

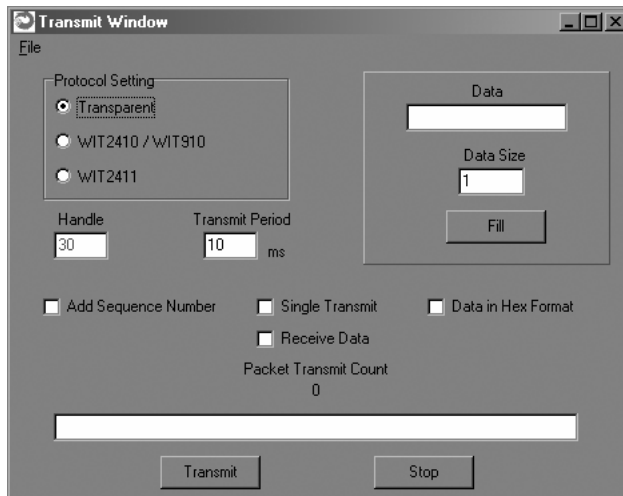

The fourth, Transmit Tools allows for testing of the Transparent, WIT2410/WIT910 or WIT2411 settings. Parameters related to how the transmission will take place can be set including Handle, Transmit Period, whether or not a Sequence Number should be added, if the Transmission will be continuous or one time, if the data should be sent in Hex Format and whether or not data can be received. Data is entered into the Data field, then Data Size can be set and clicking Fill loads the data into the Transmit Field.

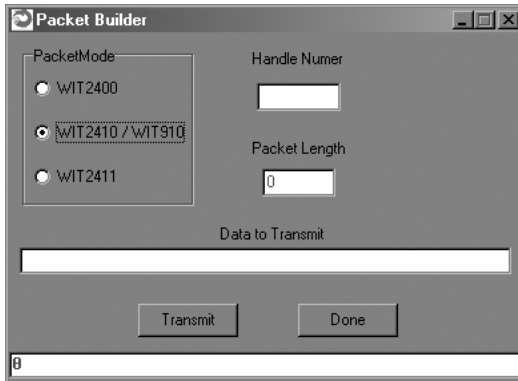

The Packet Builder is an easy way to test the multipoint addressing mode of the WIT241x radio. Since the WIT241x operates in a star configuration in multipoint mode, only the base radio needs to address data to specific remotes. All remotes send data back to the base and do not need to address the data to the base. To send a packet of data to a specific remote in a multipoint network, enter the handle of the desired remote in the Handle window. Type whatever data to be transmitted in the Data to Transmit window. In the bottom window, you will see the entire packet being built as the data is entered in the windows. When all the data has been entered, click on the Transmit button to send the data.



WinCOM has the ability to perform any function or sequence of functions WinCOM can perform through a script file. A script file is a text file that contains one or more commands and arguments save with a wcr filename extension. Each command is separated by a carriage return and linefeed. Configuration commands need to have wait periods between them. The list of commands and their definitions is below:

7.4. Script Commands

cp <arg>	Selects the COM port to use
br <arg>	Selects the baud rate to use
do	Asserts DTR
df	De-asserts DTR
ro	Asserts RTS
rf	De-asserts RTS
cm	Sends configuration escape sequence
oo	Obey CTS/RTS
of	Do not obey CTS/RTS
sc <cmd(arg)>	Send WIT910 format configuration command
wt <arg>	Pause for arg milliseconds

An example script file is shown below:

```
br 115200
df
wt 200
do
wt 200
cm
wt 200
sc m!
```

This script file sets the baud rate of the PC COM that WinCOM is using to 115,200 kbps, de-asserts DTR, waits 200 milliseconds, asserts DTR, waits 200 milliseconds, sends the configuration mode escape sequence, waits 200 milliseconds and then sends the m! command to the radio. What this script file does is set the PC COM port baud rate to 115.2 kbps, puts the radio in config mode and the issues the command to display all of the radio parameters that have been changed from factory default. Note that this script file leaves the radio in config mode. Cycling power or toggling DTR will return the radio to data mode.

WinCOM prompts you to select the desired .wcr file. Opening the script file causes it to executed immediately.

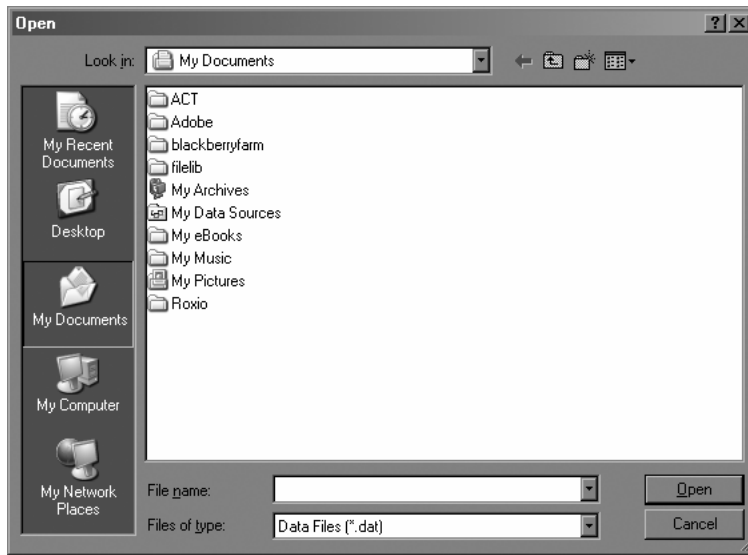

The seventh tool allows the loading of a data file for transmission. Navigate to a file then click Open and the file is transmitted immediately.

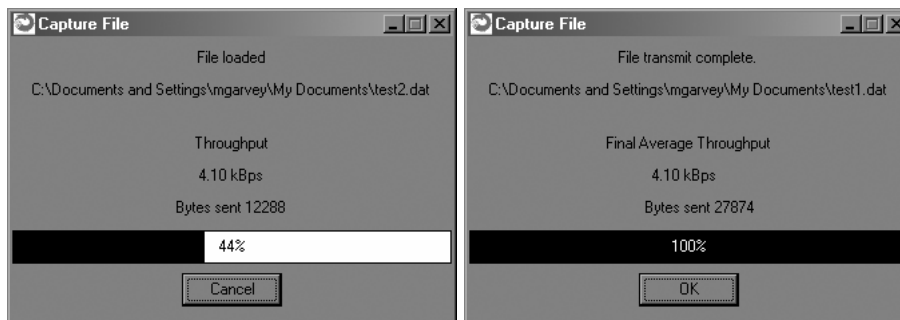

The Capture File dialog displays with a bar showing loading progression. Once the file has finished transmitting, the Final Average Throughput and Bytes sent numbers will be displayed.



Finally, the eighth tool is Save to File which launches a Save As dialog that allows any data received to be loaded into a file.

7.5. Demonstration Procedure

The procedure below provides a quick demonstration of the WIT241x.

1. Attach a transceiver to each computer, preferably between 5' and 30' apart for convenience.
2. Start WinCOM running on both computers. If you prefer, almost any other serial communications program such as Procomm or QModem set for 9600 bps will also work.
3. Turn the radios on and use the function keys to set DTR and RTS to 1 (if you are using a terminal program other than COM24, these are typically set automatically). The radio should respond by setting both DSR and CTS to 1, and transmit a short sign-on message including the firmware version and whether the unit is configured as a base or remote. Watch the states of the hardware control lines on the status bar as you do this. The DCD indicator should be lit on the base station. After a few seconds, the remote unit will acquire the base station's signal and also assert its DCD signal.
4. Access modem control mode for each unit. To access modem control mode, use the F1 key to toggle DTR to 0 and back to 1 and then press the F3 key, which sends the ":wit2400" escape sequence. If you are not using COM24, simply turn the radio off and back on and then type ":wit2400" (must be lower case, no backspace characters). The transceiver should echo back ">" to indicate that you have entered modem control mode. Check the remote unit's hopping pattern by entering "wn?" at the prompt. The remote should respond with "0", the default setting. Check that the base station's hopping pattern matches this by entering "wn?" at the base station.
5. Exit control mode by entering "z>". Do this for both radios. At this point, you should be able to type characters into either radio and see them appear at the other side. If you are using WinCOM, you can press the F6 key to transmit a repeating test pattern.
6. For a range test, disconnect the remote station from the computer and power supply. The DCD indicator should remain lit as long as the base station is in range..
7. Exit COM24 by pressing the ESC key.

8. Troubleshooting

Radio is not responding.

Make sure DTR is asserted to bring the radio out of sleep mode. DSR should be on to indicate the radio is ready.

Can't enter modem control mode.

Make sure the host data rate is correct. The WIT2411 defaults to 9600 bps asynchronous. Evaluation units do not have external access to the CFG_SEL signal; you must use the :WIT2411 power-on escape sequence to access modem control mode. The first characters typed after the radio wakes up should be the escape sequence. Make sure you type the colon (:) and enter the letters in lower case; the characters following the colon echo to show you have typed them correctly. If using the "on-the-fly" escape sequence command, make sure a pause of at least 20ms precedes the escape sequence.

Remote never detects carrier.

Check that the base station is running, and that the remote is programmed to the same hopping pattern. Also check that the hop duration for base and remote are the same, and that the remote has a non-zero link margin.

Carrier is detected, but no data appears to be received.

Make sure that RTS is asserted to enable receive character flow. In a point-to-point application, if a remote is not receiving data, check that the base's default handle is the same as the remote's. In a multipoint application, check that the remote is not configured for protocol mode and that the base is using the correct protocol format and destination handle.

Radio is interfering with other nearby circuits.

It is possible for the RF energy envelope to be rectified by nearby circuits that are not shielded for RFI, manifesting as a lower frequency noise signal. If possible, place the antenna at least 1 foot away from the transceiver module, and 3 feet from other circuit boards and obstructions. Place sensitive circuits in a grounded metal casing to keep out RFI.

Sign-on banner or modem control mode prompt is unreadable.

If the problem is repeatable, check whether the data rates between host and transceiver match.

Range is extremely limited.

This is usually a sign of poor antenna coupling. Check that the antenna is firmly connected. If possible, remove any obstructions in the near field of the antenna (~3' radius).

Transmitting terminal flashes CTS occasionally.

This indicates that the transmitter is unable to reliably get its data across. This may be the result of an interfering signal, but most often is caused by overloading of the network. Adjusting the protocol parameters may increase the network efficiency.

Receiving terminal drops characters periodically.

Set the number of retries to a high number and send a few characters. Check that the transmitted data can get through under these conditions. Sometimes this symptom is caused by an application that is explicitly dependent on the timing of the received data stream. The nature of the packetized RF channel imposes a degree of unpredictability in the end-to-end transmission delay.

Cannot communicate with the OEM module.

Make sure DTR and RTS are asserted. DSR should be on to indicate the radio is ready.

OEM Module is in an unknown state.

Use the `m0` command to restore the factory defaults. Note that the serial baud rate must be known for the module to receive this command.

9. APPENDICES

9.1. Technical Specifications

9.1.1. Ordering Information

WIT2411D OEM Module

9.1.2. Power Specifications

Vcc Input Range: 3.3v to 10.0v
 Operating Temperature Range: -40°C to +70°C

Current Consumption (Max transmit power, 921.6Kbps I/O)

Mode	Remote	Base Station
Sleep	50μA	N/A
Standby	100mA	N/A
Typical Average	170mA	200mA
Peak (Tx)	245mA	245mA

9.1.3. RF Specifications

FCC Certification	Part 15.247, no license required
ETSI (European) Certification	brETSI 300.328, no license required
Rated RF Power	+18 dBm (+20 dBm effective radiated)
Line-of-site Range	approx. 6/10 of a mile w/2dB dipole
Frequency Range	2401 – 2495MHz
Number of Channels	43, 27 or 15 depending on hop set
Receiver Sensitivity	-89dBm
Channel Data Rate	1.2288Mbps

9.1.4. Mechanical Specifications

Weight	48g
Dimensions (including shield)	88.9 x 70.0 x 10.5mm (refer to section 7.6 for mechanical drawing)
RF Connector:	
WIT	Huber/Suhner: 85 MMCX 50-0-1
Mating	Huber/Suhner: 11 MMCX-50-2-3 (straight) Huber/Suhner: 16 MMCX-50-2-2 (rt. angle)
Data/Power Connector:	
WIT	Samtec: DIS5-108-51-L-D
Mating	Samtec: CLP-108-02-G-D (PCB mount) Samtec: FFSD-08 (IDC cable)

9.2. Serial Connector Pinout

Signal	WIT2411D OEM Pinout	HN-511 DB9 Pinout
GND	1	5
TXD	2	3
RXD	3	2
CFG	4	-
RTS	5	7
SLEEP	6	4
DCD	7	1
CTS	8	8

The HN-511 is wired as a DCE device and as such can be connected to DTE devices such as PCs with a straight-through cable. When connecting a HN-511 to a DTE device, a “null modem” cable is required. To effect a null modem cable, cross-wire TXD and RXD and connect ground. The HN-511 can operate with just these three wires connected. However, as the WIT2411 does not support software flow control, there will be no flow control in this mode. If the DTE device fails to respond, connect DCD from the HN-511 to the DTR and RTS inputs to activate the DTE device whenever the WIT2411 asserts carrier.

When connecting to the WIT2411D, make sure that all of the inputs (TXD, CFG, RTS and SLEEP) are terminated for proper operation.

9.3. Approved Antennas

The WIT2411D is designed to ensure that no antenna other than the one fitted shall be used with the device. The end user must permanently affix the antenna by using an adhesive on the coupling such as *Loctite*, or ensure the antenna has a unique coupling. The table below lists the antennas which can be purchased directly from Cirronet. Contact Cirronet Technical Support with any questions.

Description	Gain	Part Number	Coupling
15dB Yagi Directional	15dB	YAGI2415	N
14dB Corner Reflector	14dB	CORNER2414	N
12dB Cirronet Patch	12dB	PA2412	RF cable w/MMCX
9dB Omnidirectional	9dB	OMNI249	N
9dB Corner Reflector	9dB	CORNER249	N
6dB Cirronet Patch	6dB	PA2400	MMCX
5dB Mobile Mount	5dB	MAG245	N
2dB Cirronet Patch	2dB	PA2410	MMCX
2dB Rugged Body Mount	2dB	RBM242	N
Dipole	2dB	RWA249R	Reverse SMA

9.4. Technical Support

For technical support call Cirronet™ at (678) 684-2000 between the hours of 8:30AM and 5:30PM Eastern Time.

9.5. Reference Design

Optional pullups to keep
RTS and DTR asserted
when left unconnected

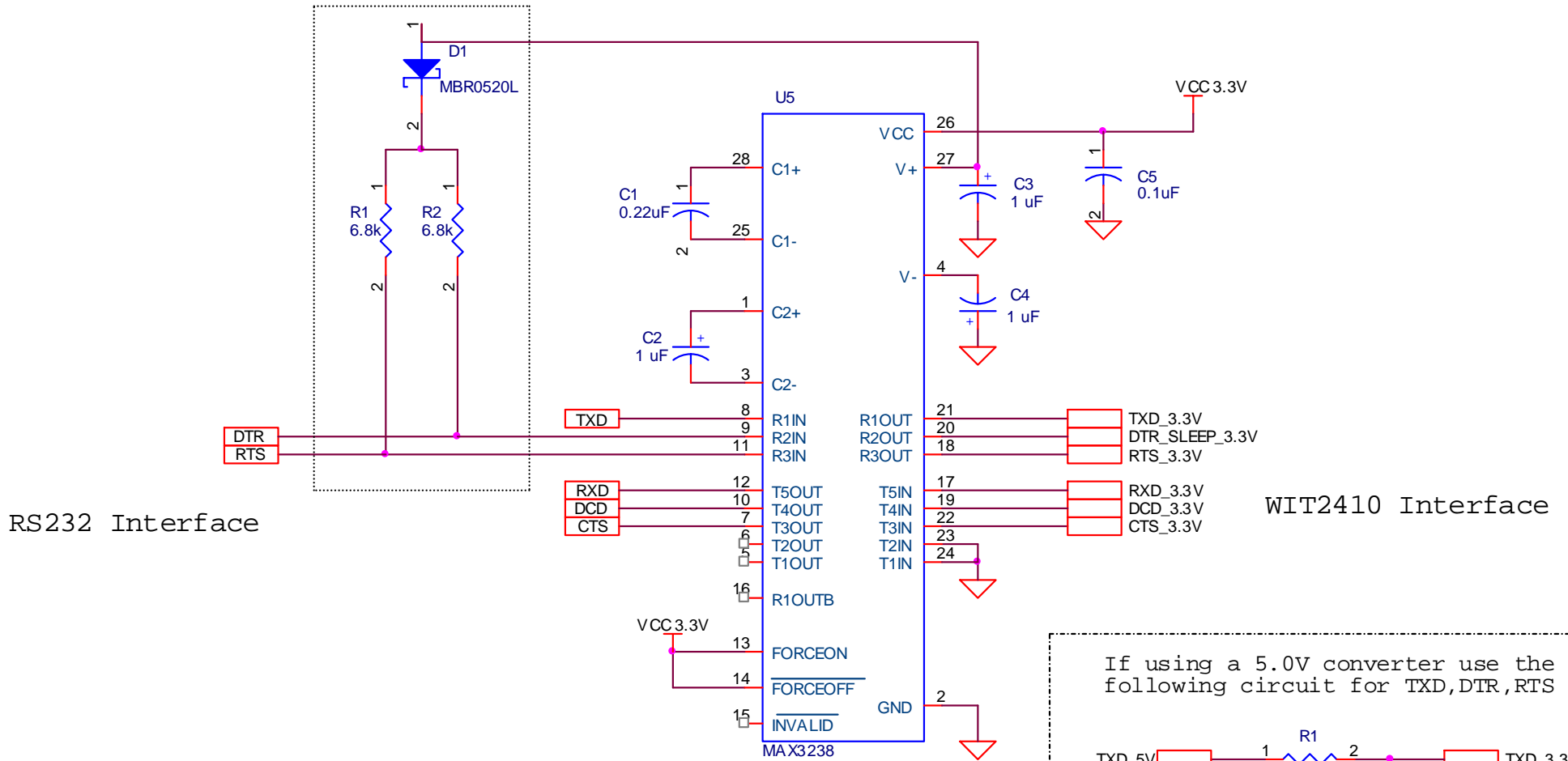

RS232 Interface

WIT2410 Interface

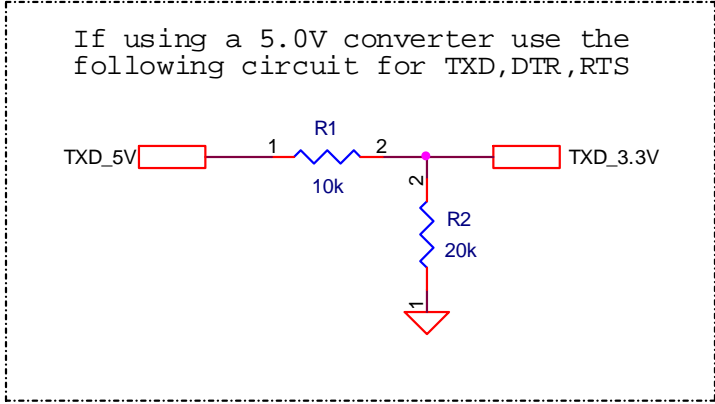

9.6. Mechanical Drawing – WIT2411D

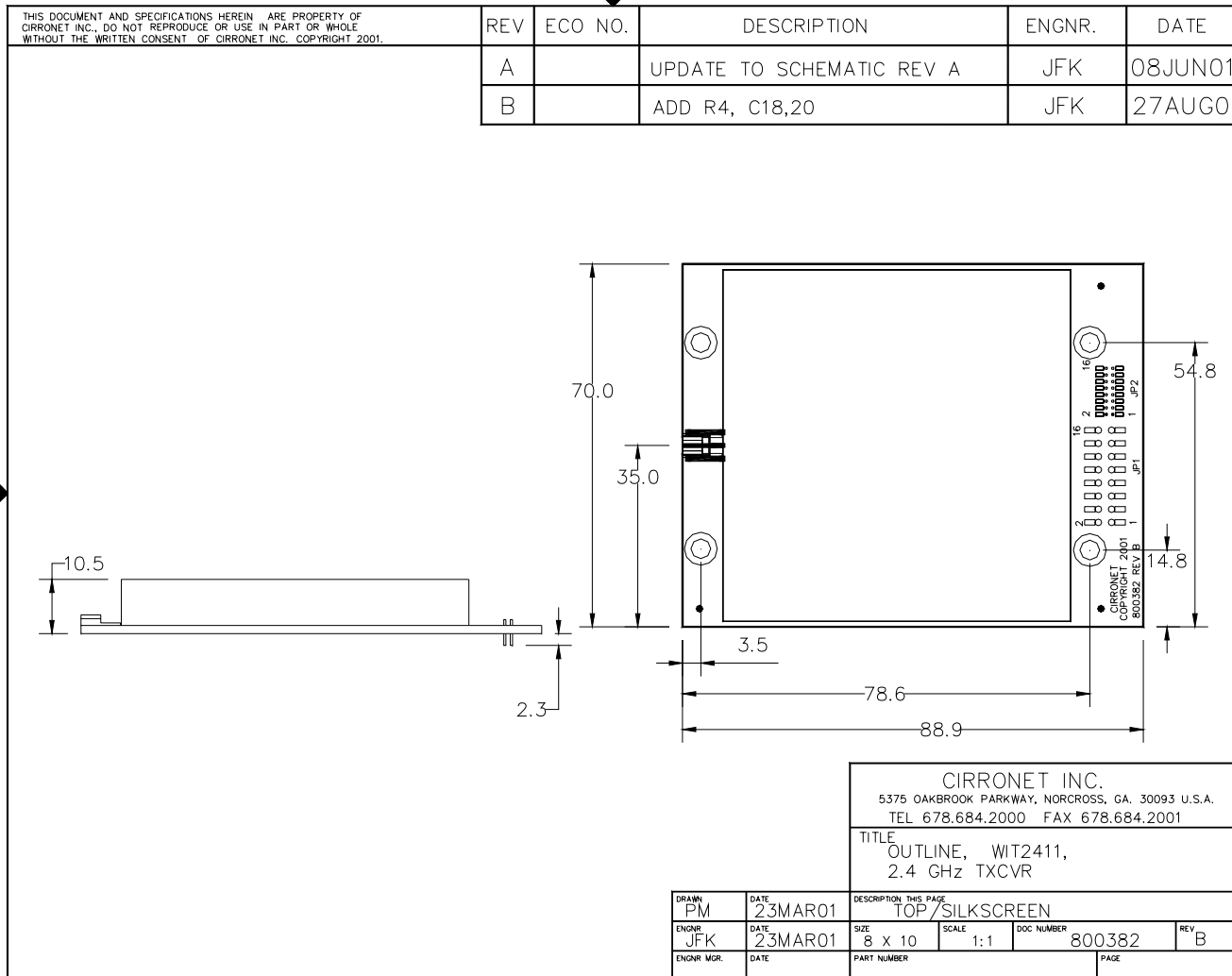

10. Warranty

Seller warrants solely to Buyer that the goods delivered hereunder shall be free from defects in materials and workmanship, when given normal, proper and intended usage, for twelve (12) months from the date of delivery to Buyer. Seller agrees to repair or replace at its option and without cost to Buyer all defective goods sold hereunder, provided that Buyer has given Seller written notice of such warranty claim within such warranty period. All goods returned to Seller for repair or replacement must be sent freight prepaid to Seller's plant, provided that Buyer first obtain from Seller a Return Goods Authorization before any such return. Seller shall have no obligation to make repairs or replacements which are required by normal wear and tear, or which result, in whole or in part, from catastrophe, fault or negligence of Buyer, or from improper or unauthorized use of the goods, or use of the goods in a manner for which they are not designed, or by causes external to the goods such as, but not limited to, power failure. No suit or action shall be brought against Seller more than twelve (12) months after the related cause of action has occurred. Buyer has not relied and shall not rely on any oral representation regarding the goods sold hereunder, and any oral representation shall not bind Seller and shall not be a part of any warranty.

THE PROVISIONS OF THE FOREGOING WARRANTY ARE IN LIEU OF ANY OTHER WARRANTY, WHETHER EXPRESS OR IMPLIED, WRITTEN OR ORAL (INCLUDING ANY WARRANTY OR MERCHANT ABILITY OR FITNESS FOR A PARTICULAR PURPOSE). SELLER'S LIABILITY ARISING OUT OF THE MANUFACTURE, SALE OR SUPPLYING OF THE GOODS OR THEIR USE OR DISPOSITION, WHETHER BASED UPON WARRANTY, CONTRACT, TORT OR OTHERWISE, SHALL NOT EXCEED THE ACTUAL PURCHASE PRICE PAID BY BUYER FOR THE GOODS. IN NO EVENT SHALL SELLER BE LIABLE TO BUYER OR ANY OTHER PERSON OR ENTITY FOR SPECIAL, INCIDENTAL OR CONSEQUENTIAL DAMAGES, INCLUDING, BUT NOT LIMITED TO, LOSS OF PROFITS, LOSS OF DATA OR LOSS OF USE DAMAGES ARISING OUT OF THE MANUFACTURE, SALE OR SUPPLYING OF THE GOODS. THE FOREGOING WARRANTY EXTENDS TO BUYER ONLY AND SHALL NOT BE APPLICABLE TO ANY OTHER PERSON OR ENTITY INCLUDING, WITHOUT LIMITATION, CUSTOMERS OF BUYERS.